

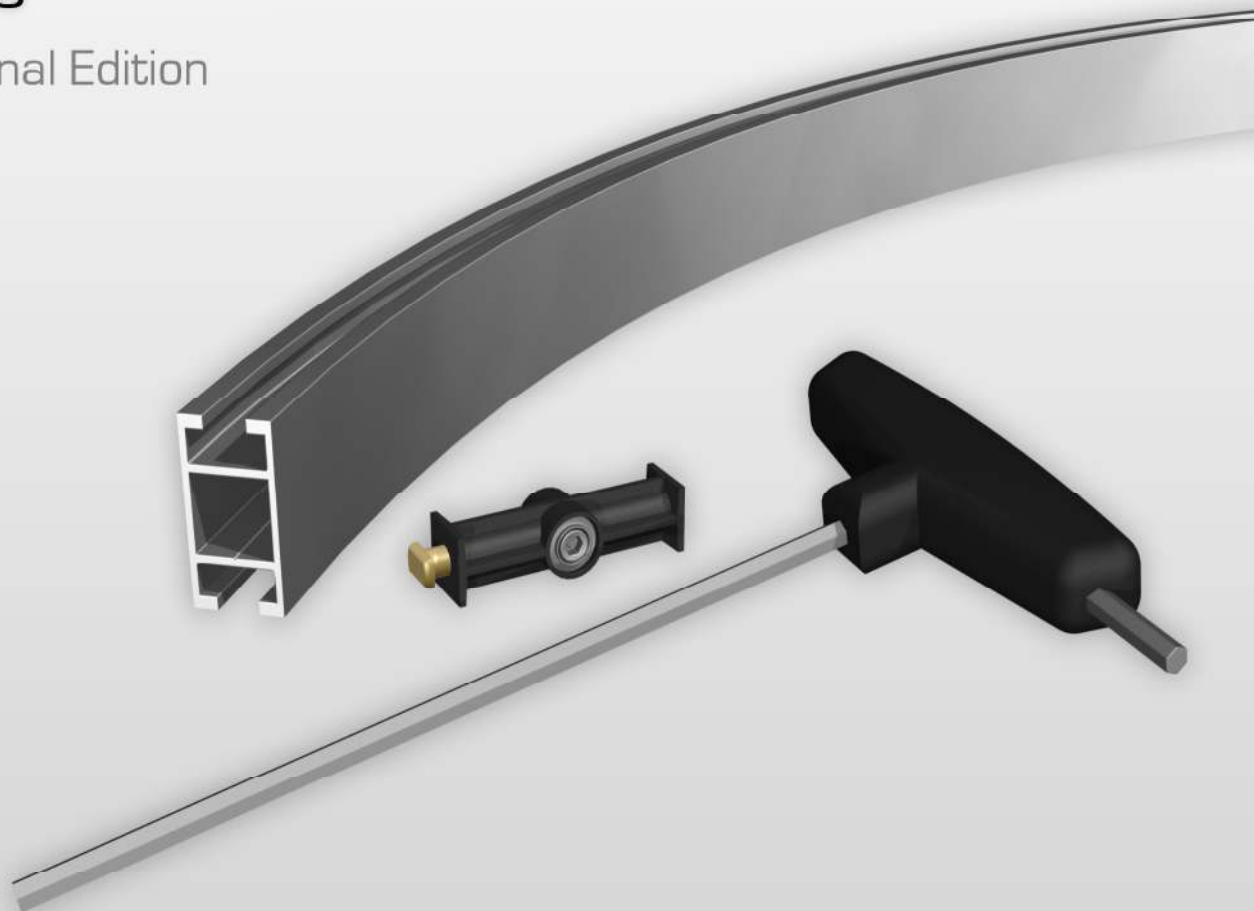

Profiles

International Edition



FOGA Profiles...

Details of all current FOGA profiles.

Standard Profiles

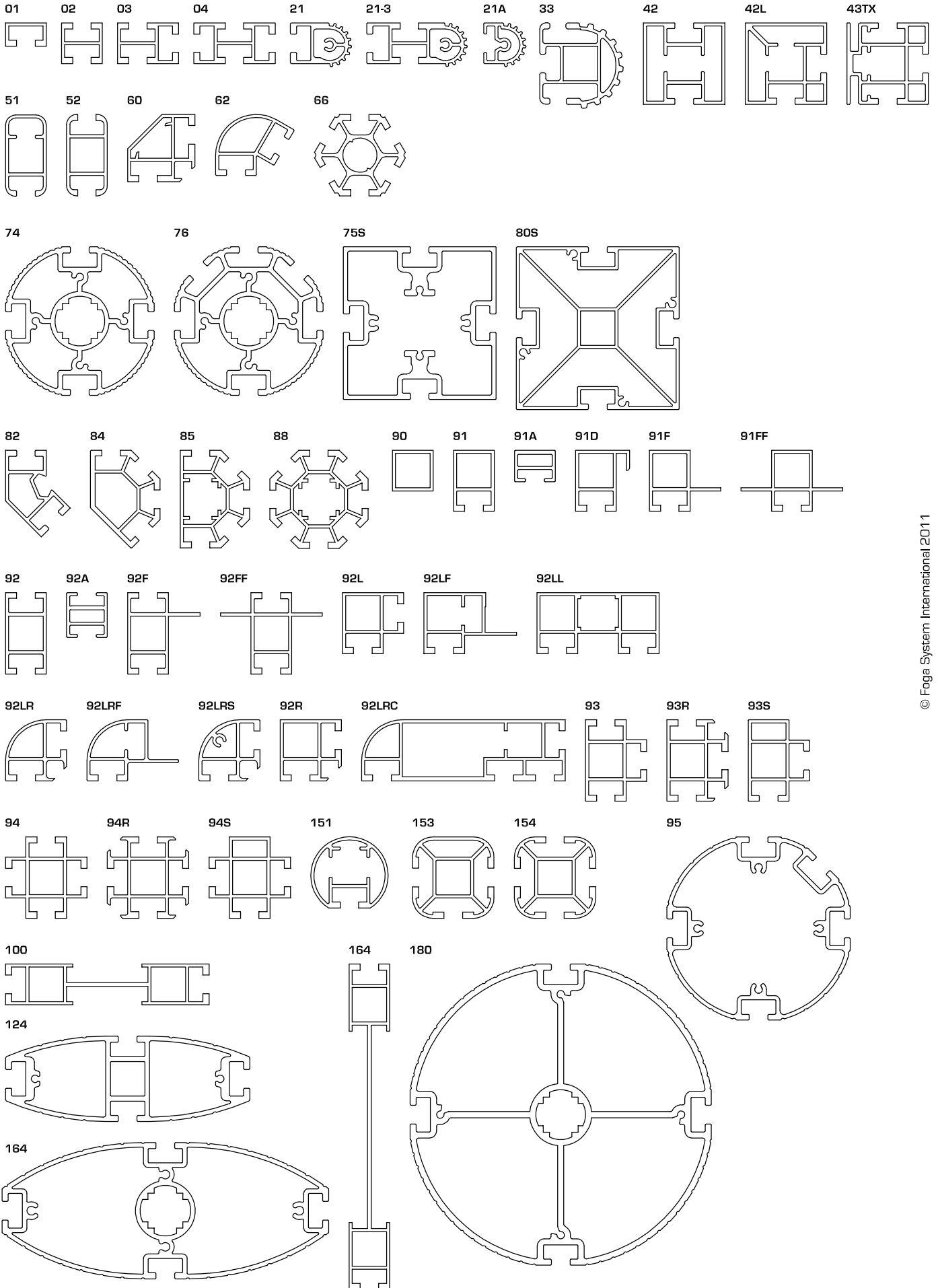

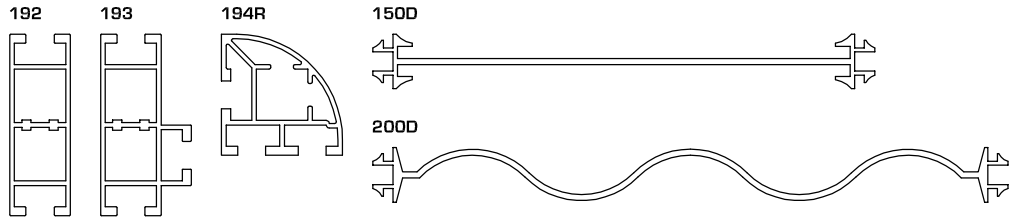
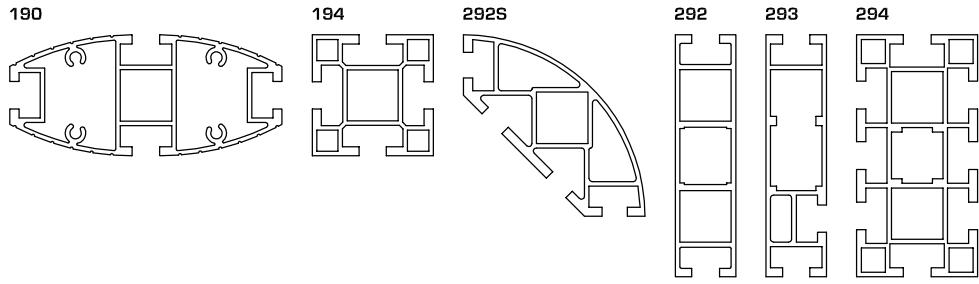

Special Purpose Profiles

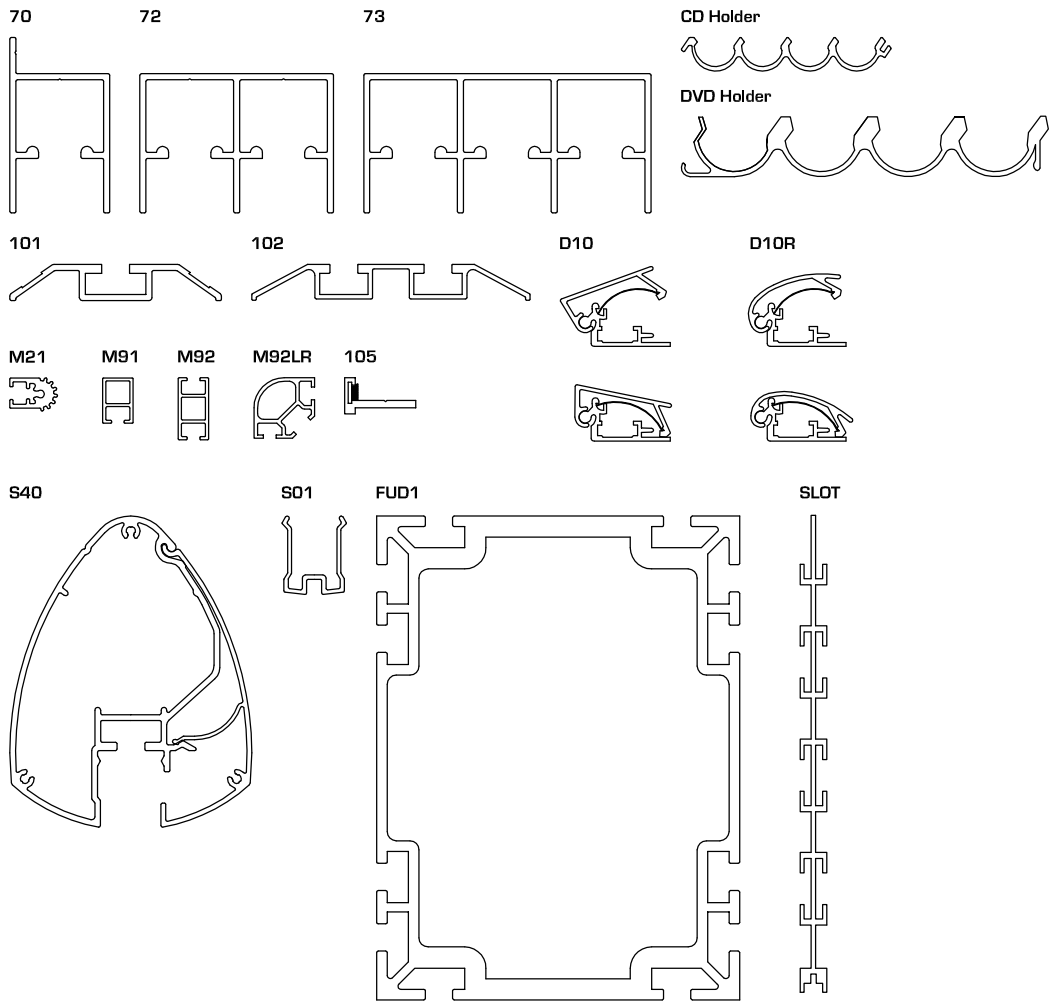

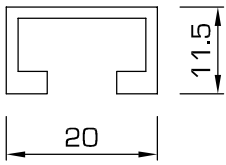
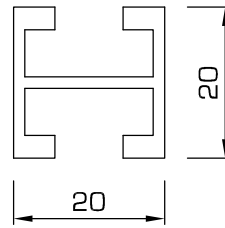
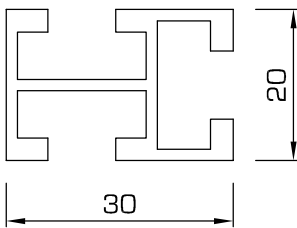
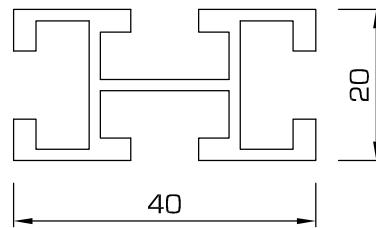
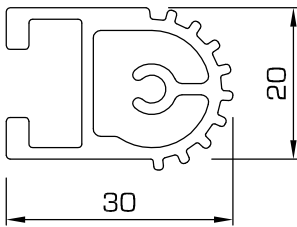
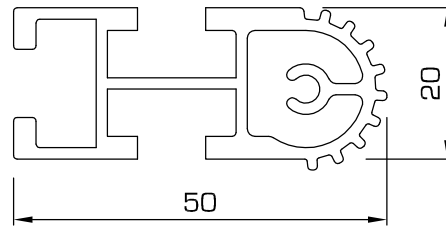
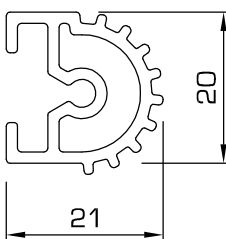
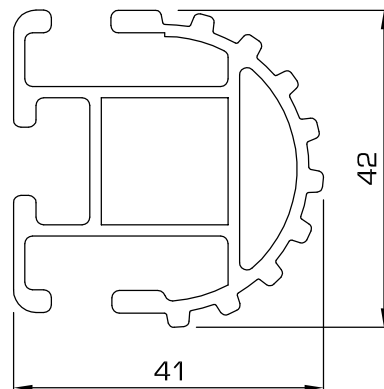
01 - Single channel**02** - Twin channel**03** - Three-way channel**04** - Four-way channel**21** - Gear edged, produces hinge**21-3** - Gear edged, produces hinge**21A** - Gear edged, produces hinge. Use with 600AC coupling and profiles 91A and 92A**33** - Gear edged, produces hinge

42 - Upright or rail, square

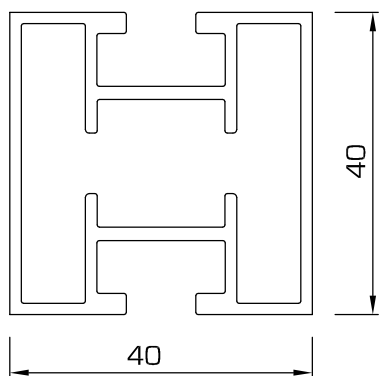

42L - Upright or rail, square

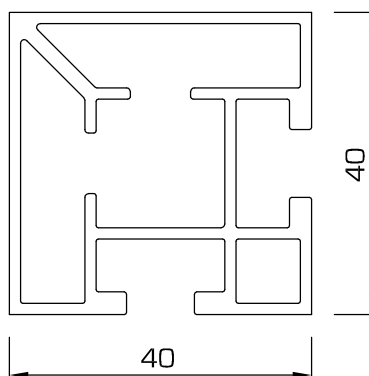

43TX - Forms tensioned fabric walls, use with 613 connector and 350TX silicone strip

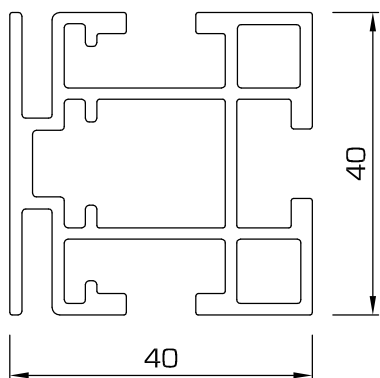

51 - Upright or rail, one-way, radius corners

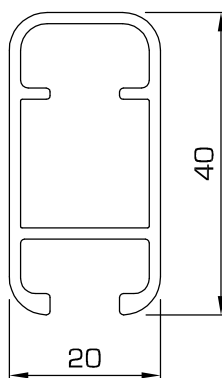

52 - Upright or rail, two-way, radius corners

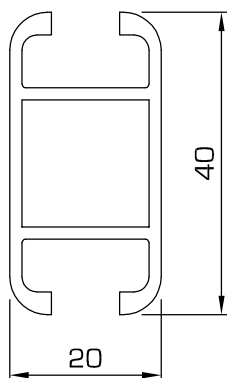

60 - Upright or rail, 90° corner

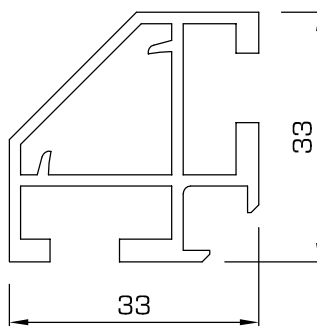

62 - Upright, 60° corner

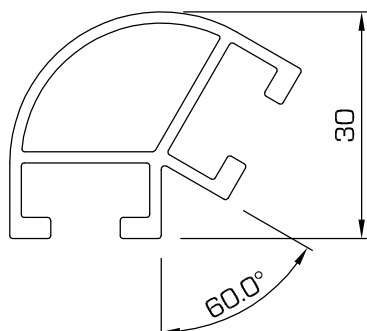

66 - Upright

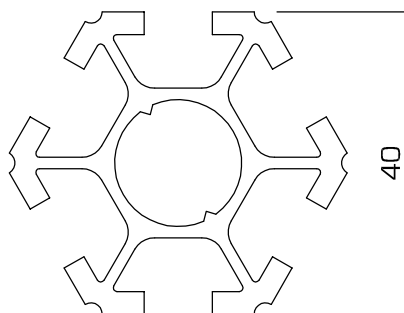

74 - Upright, four-way circular profile with ribbed finish

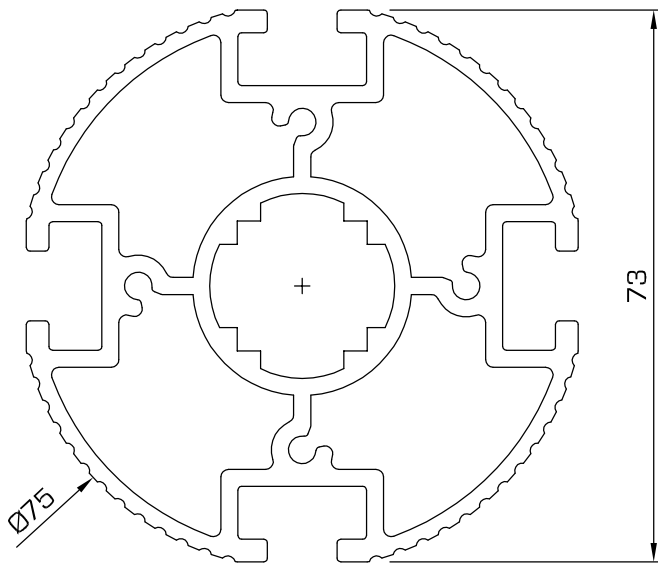

76 - Upright, six-way circular profile with ribbed finish

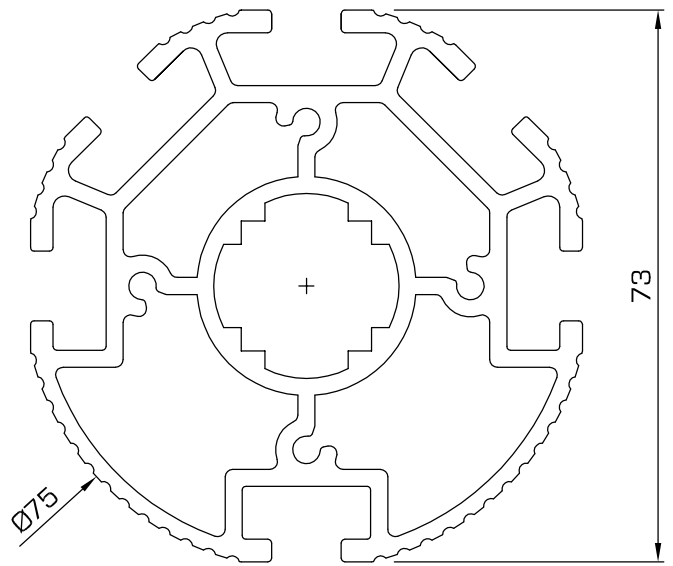

75S - Upright or rail, square

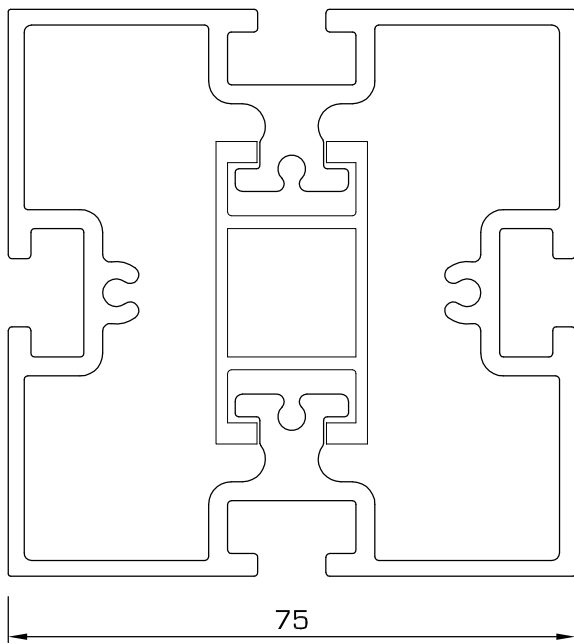

80S - Upright or rail, square

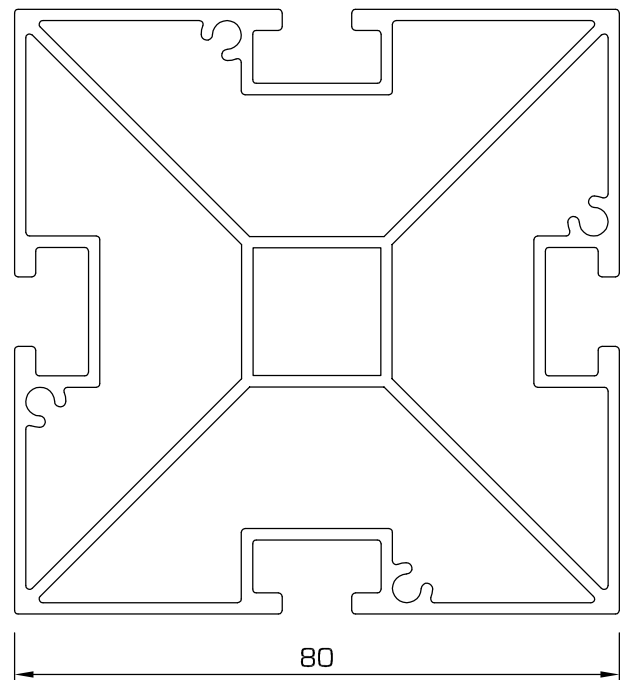

© Foga System International 2011

82 - Upright, 135°, inside shelf support



84 - Upright, 135°

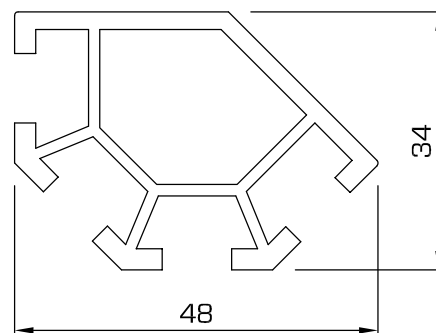

85 - Upright, 180°

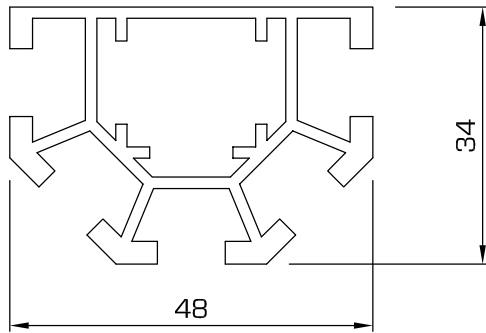

88 - Upright

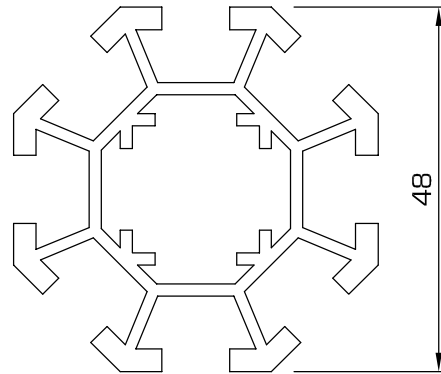

90 - Upright or rail, square

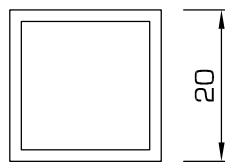

91 - Upright or rail

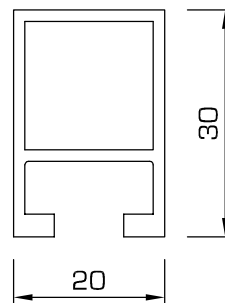

91A - Upright or rail, use 600AC connector

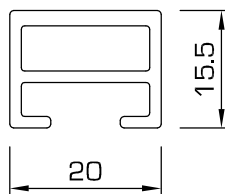

91D - Sign profile for 4mm panels

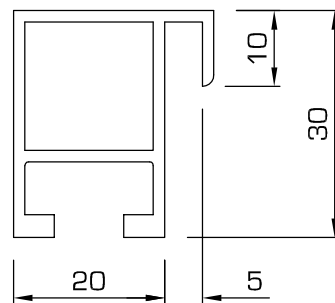

91F - Rail, with flange

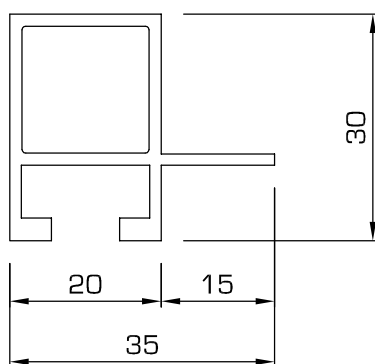

91FF - Rail, with twin flange

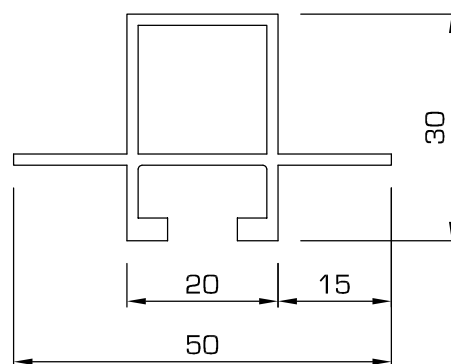

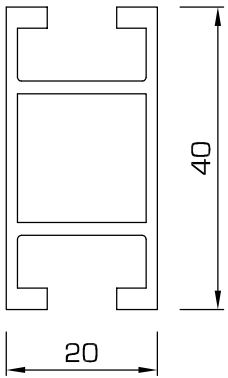
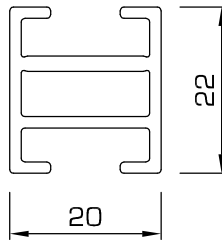
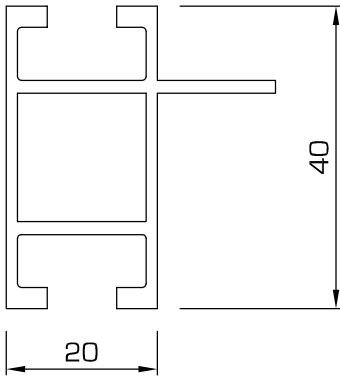
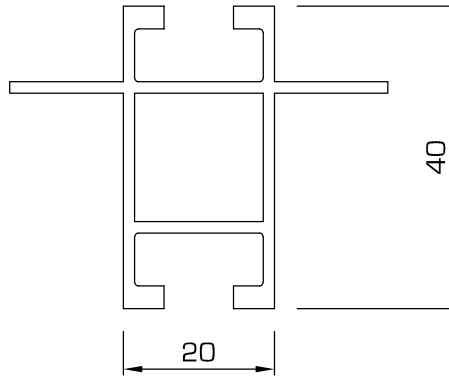
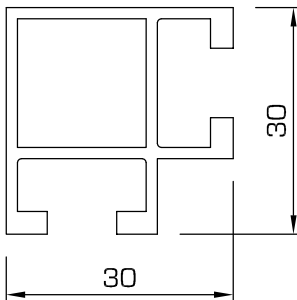
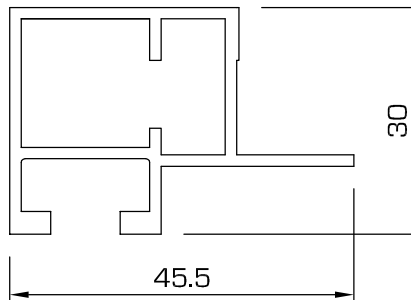
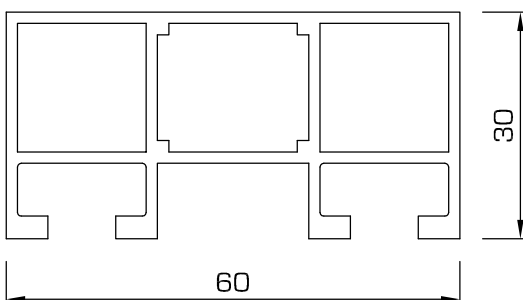
92 - Upright or rail**92A** - Upright or rail, use 600AC connector**92F** - Rail, with flange**92FF** - Rail, with twin flange**92L** - Upright or rail, 90° corner**92LF** - Rail, 90° corner with flange**92LL** - Upright or rail, double 90° corner

92LR - Upright or rail, 90° corner with shelf support

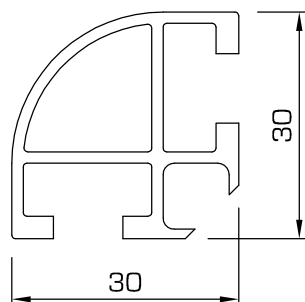

92LRF - Rail, 90° corner with flange

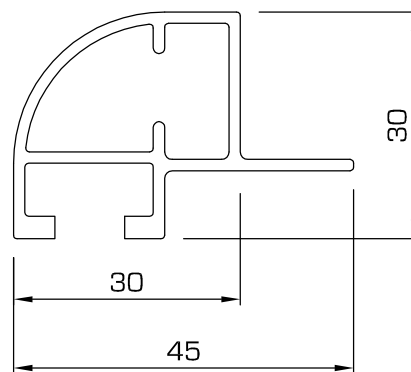

92LRS - Upright or rail, 90° corner with shelf support and screw port

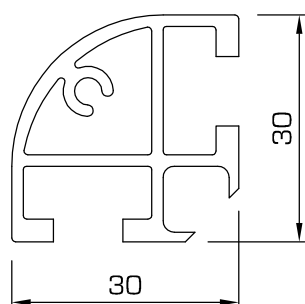

92R - Upright or rail, 90° corner with shelf support

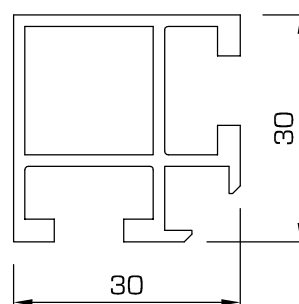

92LRC - Extra wide profile (for wall mounted showcases)

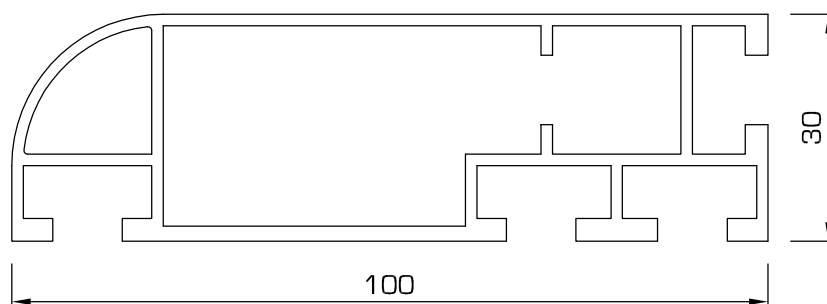

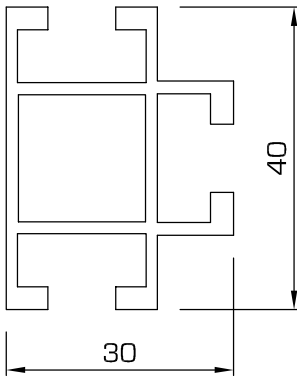
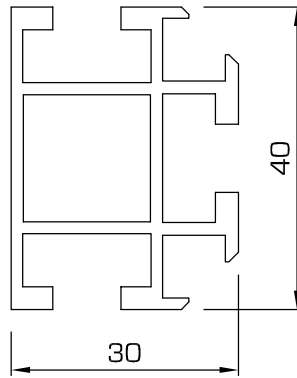
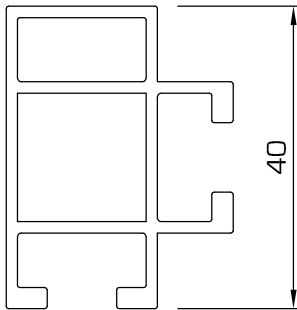
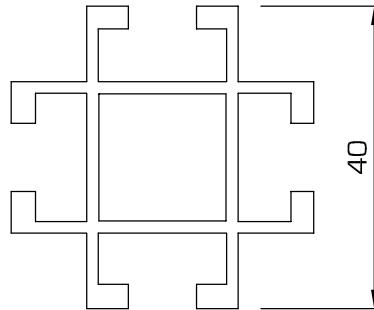
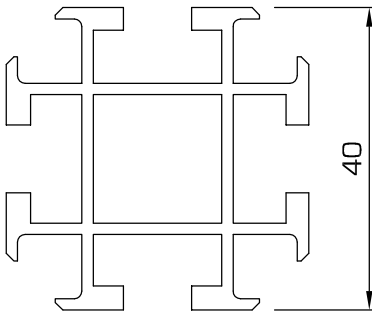
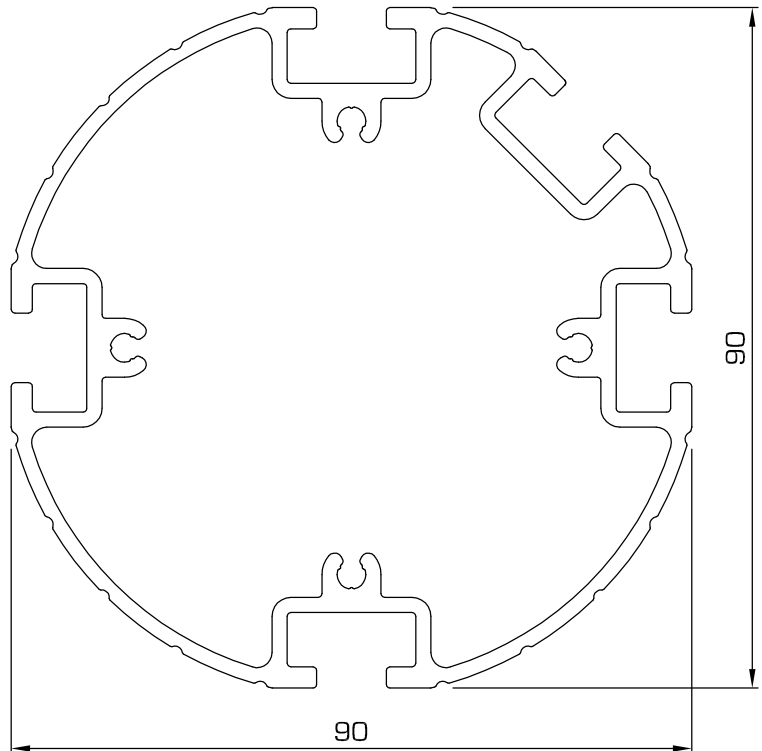
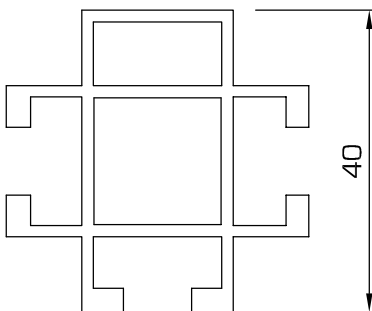
93 - Upright or rail**93R** - Upright, with shelf support**93S** - Upright or rail**94** - Upright or rail**94R** - Upright, with shelf support**95** - Upright, medium circular profile with ribbed finish**94S** - Upright or rail

100 - 100mm deep fascia rail

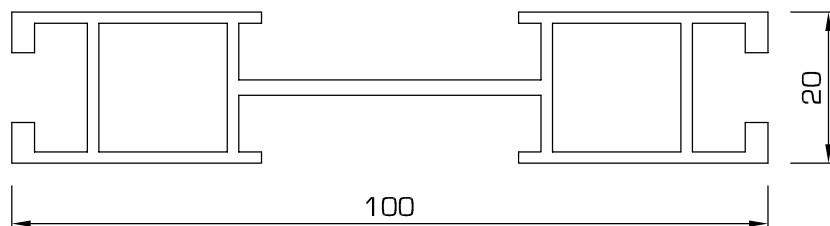

124 - Upright, medium elliptical profile with ribbed finish

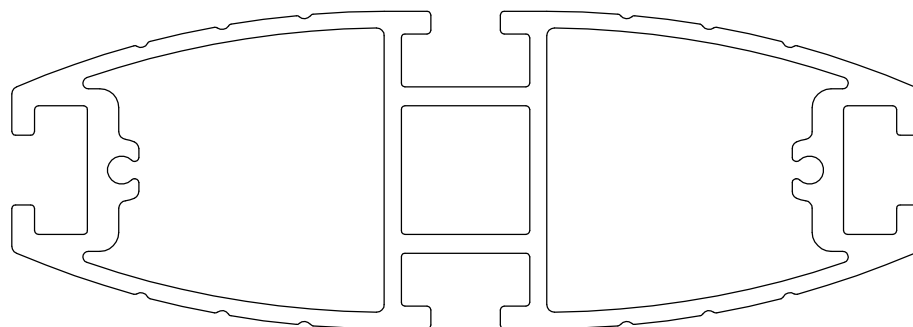

150D - Decorative infill that slides in FOGA channels, can be used vertically or horizontally

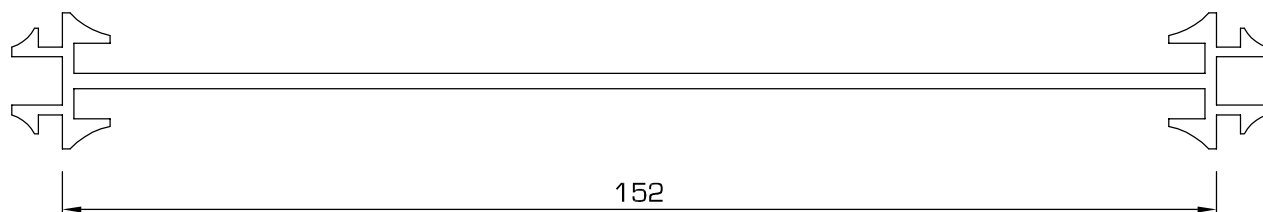

153 - Upright or rail, square, radius corners

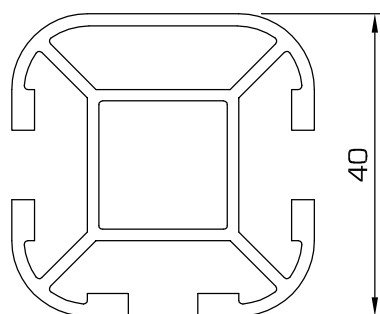

154 - Upright or rail, square, radius corners

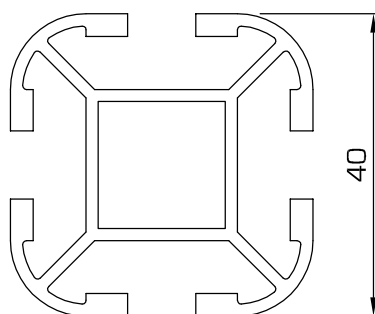

151 - Upright or rail, round

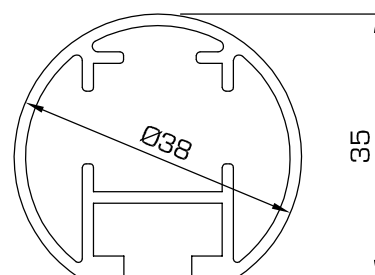

164 - Upright, large elliptical profile with ribbed finish

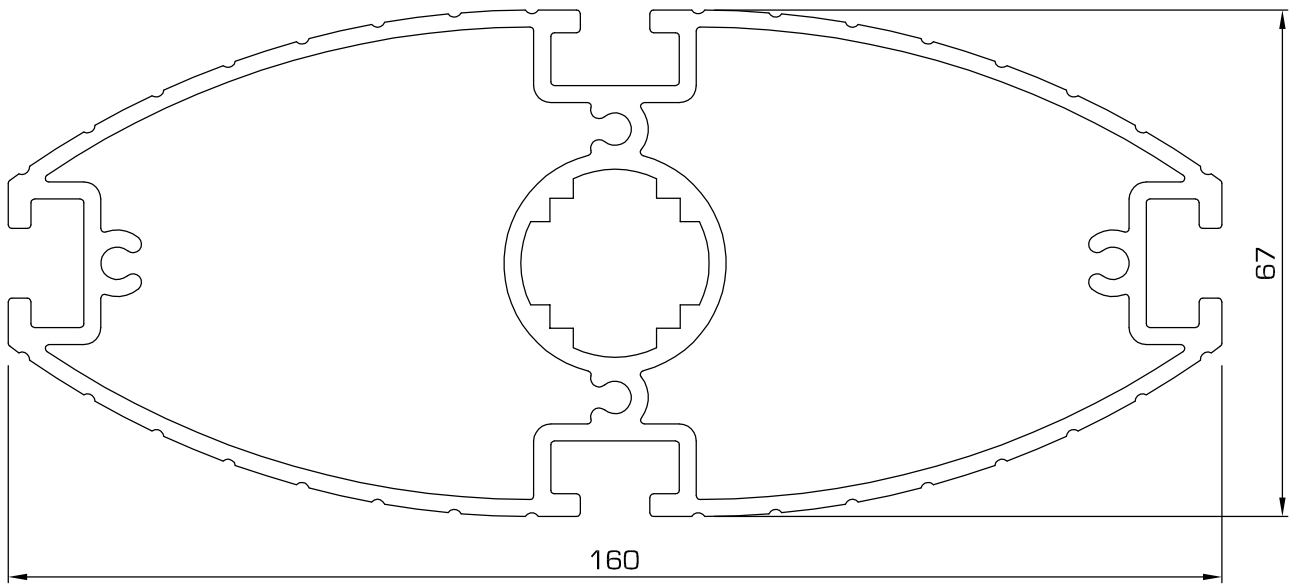

190 - Upright, small elliptical profile with ribbed finish

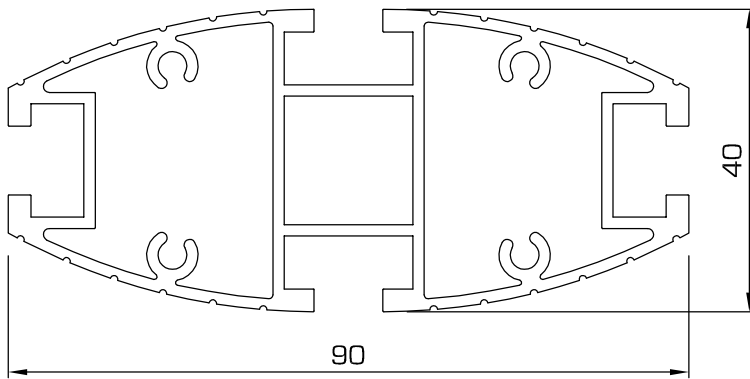

194 - Upright or rail, square

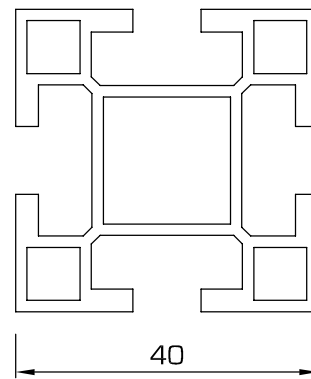

192 - Upright or rail

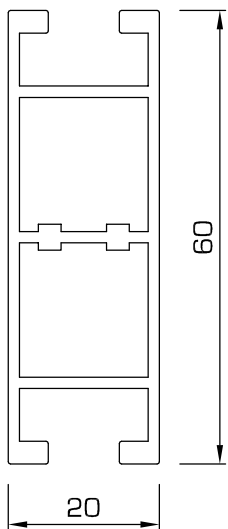

193 - Upright or rail

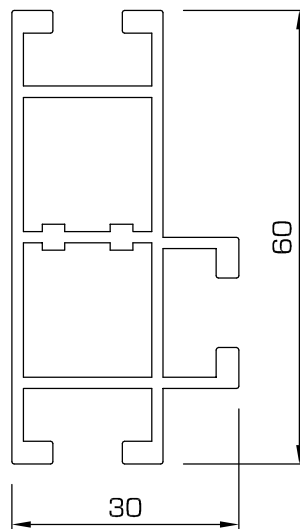

194R - Upright or rail, 90° corner

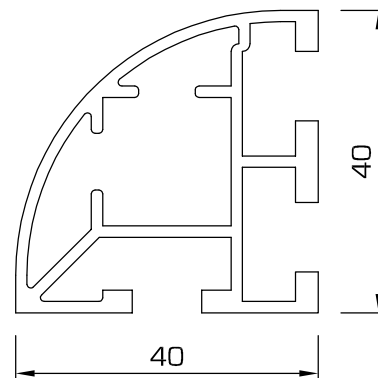

160 - 100mm deep fascia rail

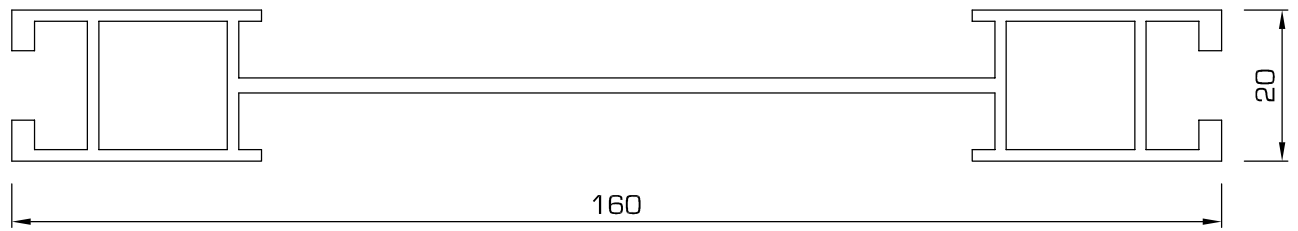

180 - Upright, large circular profile with ribbed finish with central boss

180A - Same as profile 180 but without central boss

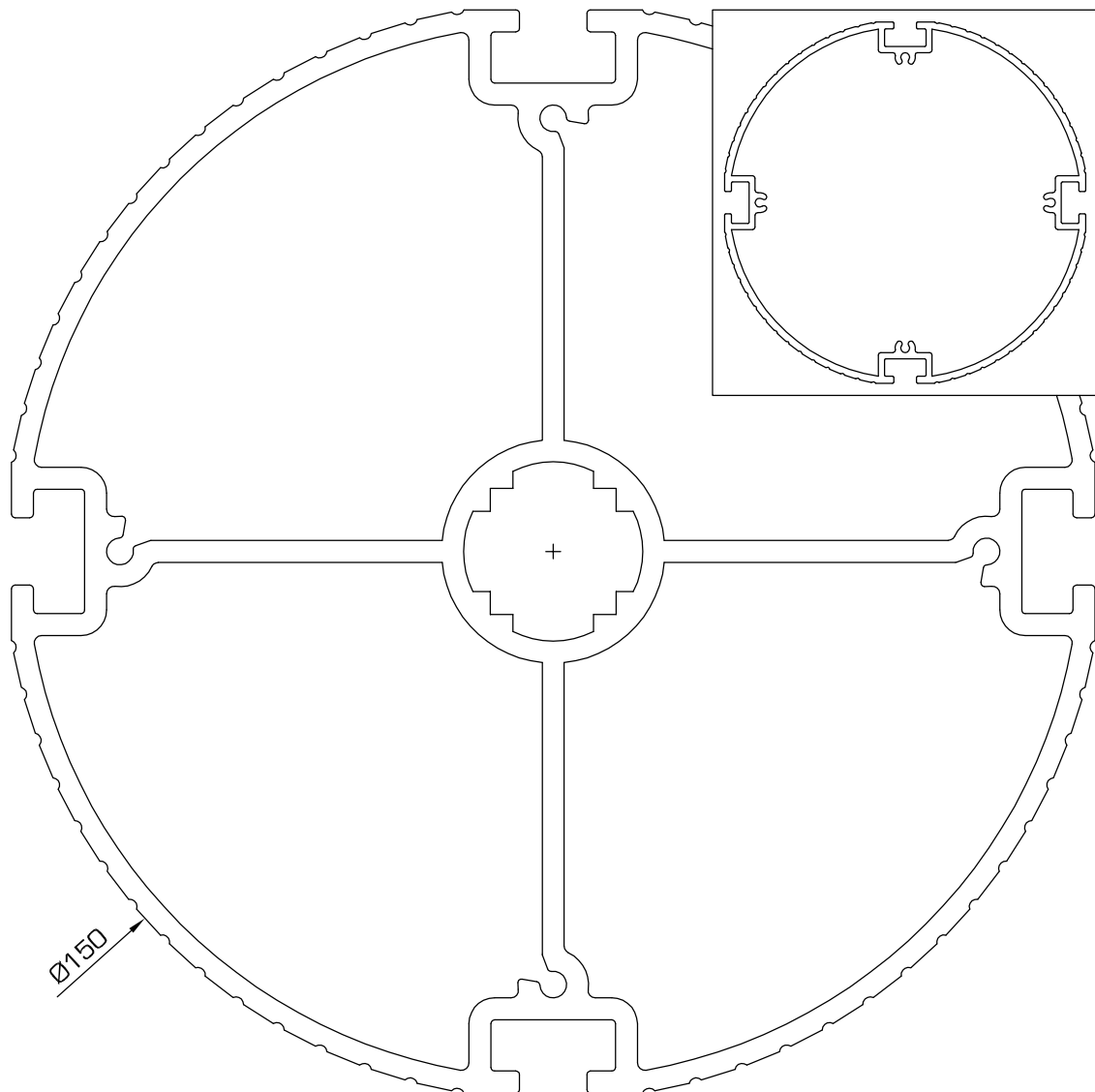

292 - Upright or rail

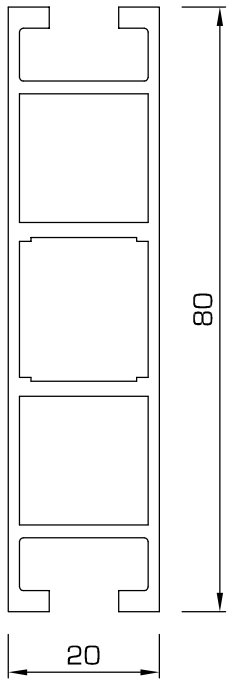

292S - Upright or rail, large 90° corner

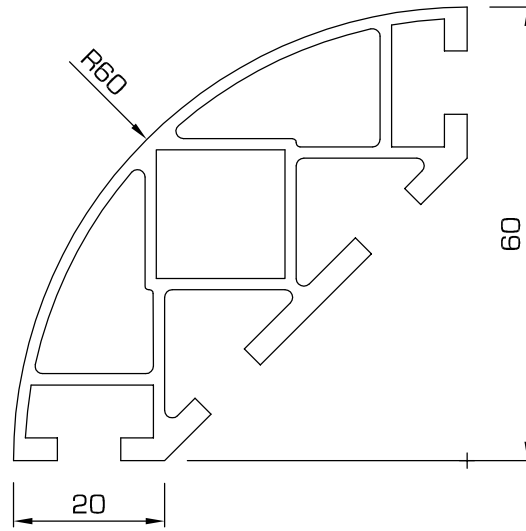

200D - Decorative infill can be used vertically or horizontally

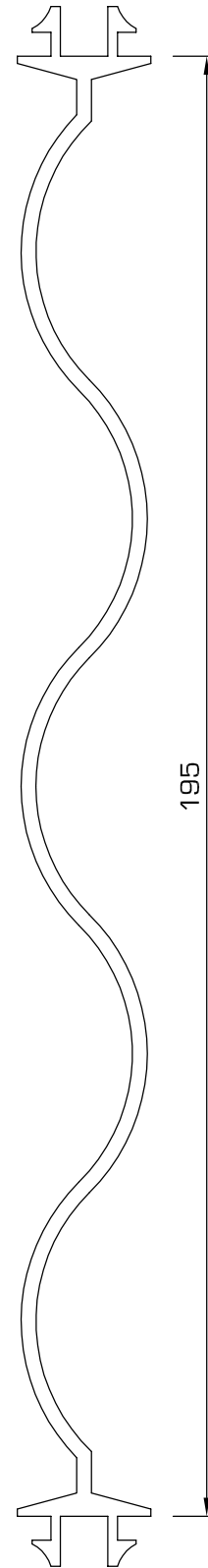

293 - Upright or rail

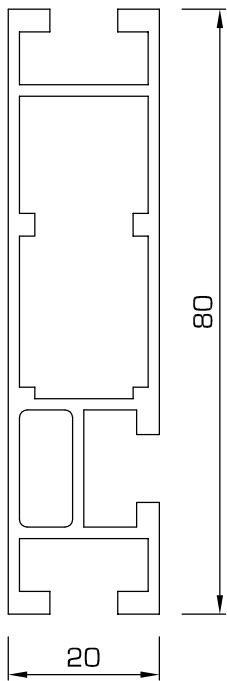

294 - Upright or rail, for larger structural designs

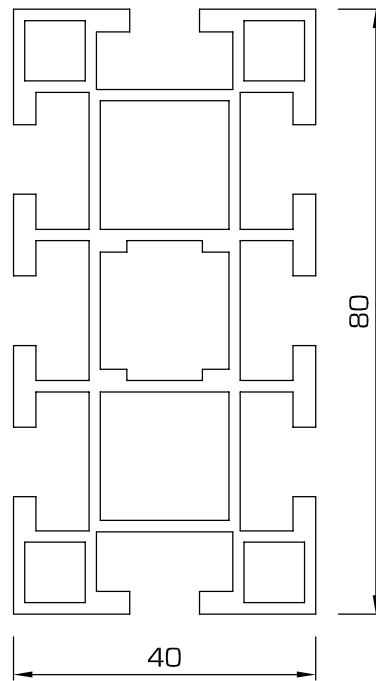

70 - Single channel sliding door track

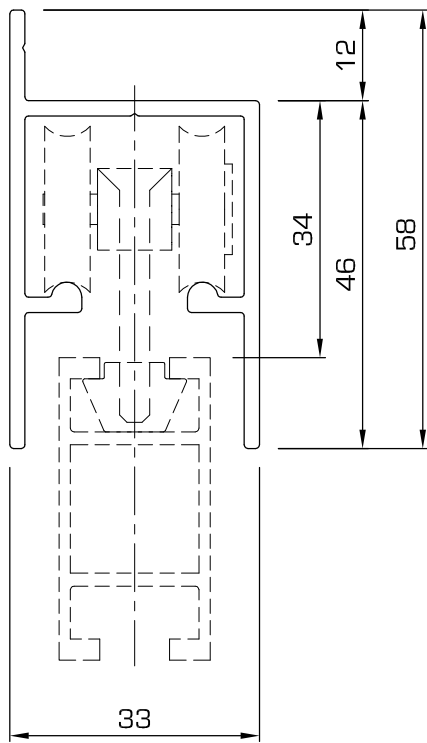

72 - Twin channel sliding door track

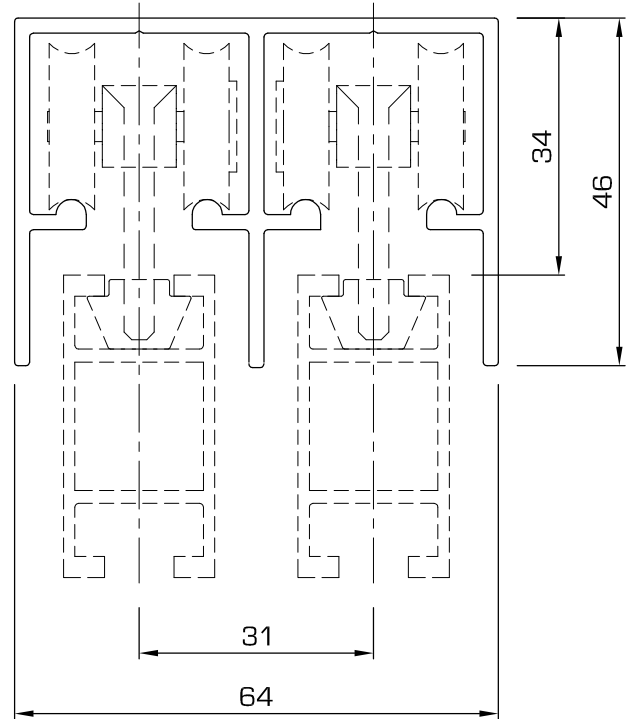

73 - Triple channel sliding door track.

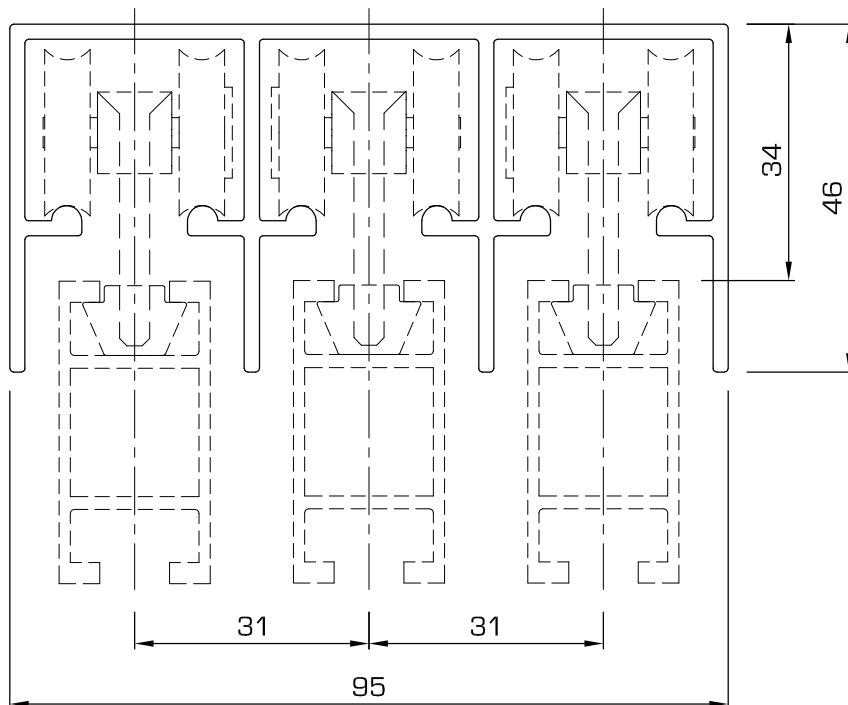

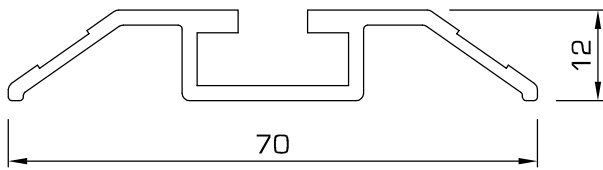
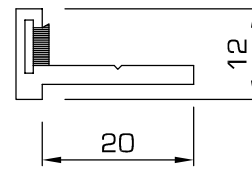
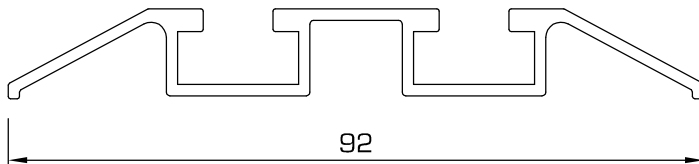
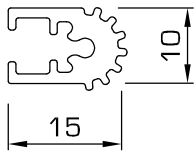
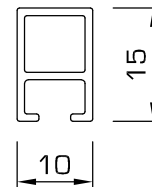
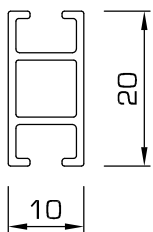
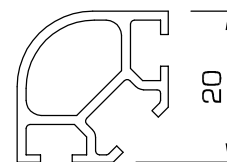
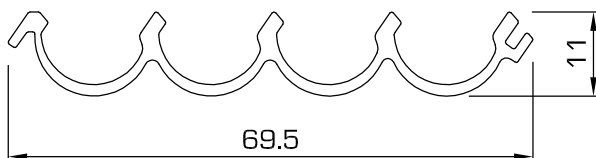
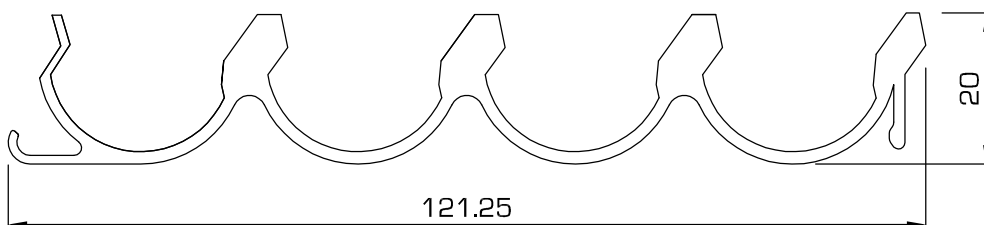
101 - Threshold rail with single channel**105** - Doorstop with wool pile**102** - Threshold rail with twin channel**M21** - FOGA Mini - Gear edged, produces hinge**M91** - FOGA Mini - Upright or rail**M92** - FOGA Mini - Upright or rail**M92LR** - FOGA Mini - Upright or rail, 90° corner**CD Holder** - For browsing CDs in standard jewel cases**DVD Holder** - For browsing DVDs in standard cases

D10 - Clip frame with flat front

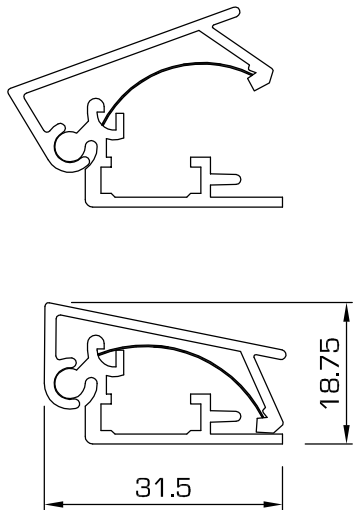

D10R - Clip frame with curved front

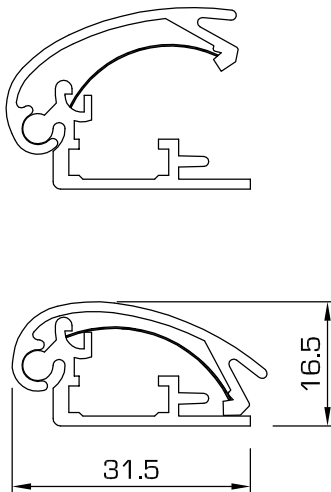

SLOT - Slotwall adaptor - fits together vertically to produce slatwall to any required height

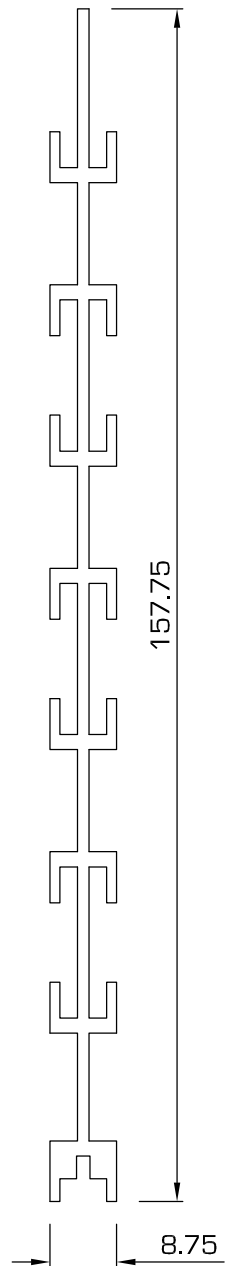

S40 - Post profile, specially for signs

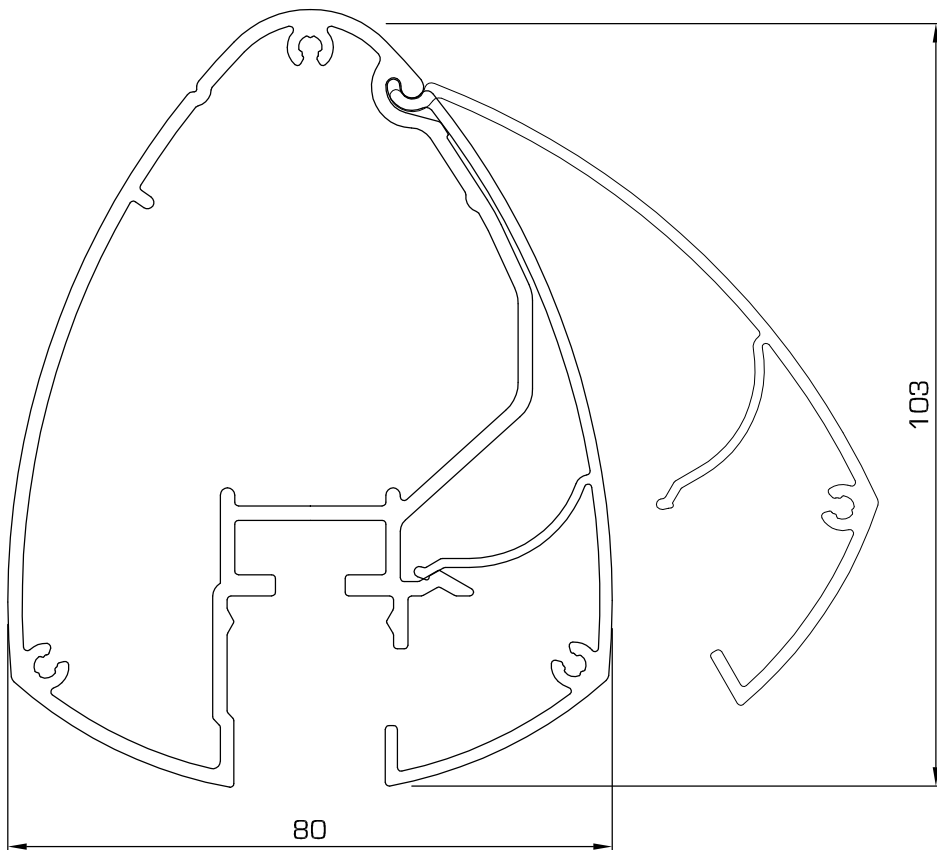

S01 - Aluminium trim for post profile S40

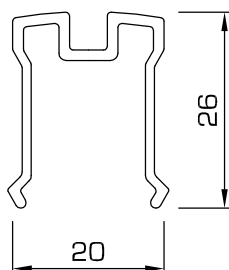

FUD1 - FOGA Upperdeck profile, for two-storey exhibition stands